

GRIPfit raccordi super-rapidi Serie 7000 - Beverage and Water filtration

Diametri esterni tubo: 4, 6, 8 mm

Filetti dei raccordi: Gas cilindrici ISO-228 BSPP (G1/8, G1/4, G3/8).



- » Materiali di origine biologica (composito)
- » Ottone a basso contenuto di piombo (CW510L)
- » Facile connessione e disconnessione

La serie 7000 Beverage and Water filtration è una nuova gamma di raccordi push-in realizzata in tecnopolimero rinforzato di origine biologica e ottone a basso contenuto di piombo. Grazie a questi materiali e ad una nuova tecnologia di connessione, questi raccordi sono ideali per i sistemi di erogazione di bevande e di filtrazione dell'acqua.

*Verificare i modelli certificati NSF sul sito <https://www.nsf.org/certified-products-systems>

** NSF169 e NSF61 disponibili da subito per i raccordi dritti in ottone. Presto disponibili per l'intera gamma.

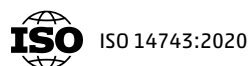

CARATTERISTICHE GENERALI

Diametri	Ø 4 mm - Ø 6 mm - Ø 8 mm
Pressione d'esercizio massima	-20° / +40° 16 bar - 16 bar - 16 bar +40° / +70° 16 bar - 14 bar - 12 bar +70° / +100° 16 bar - 12 bar - 10 bar
Pressione d'esercizio minima	-0,9 bar
Temperatura	-20 ÷ +100 (Vedere caratteristiche tubi impiegati)
Filettature	GAS cilindrico ISO-228 BSPP
Tubo di collegamento	Poliuretano (PU), Polietilene (PE), Poliammide (PA), Fluoropolimero (PTFE), Poliestere (HY3L), tubo metallico rigido con estremità metallica scanalata liscia
Fluido	Acqua di rete e potabile, bevande e gas (per altri fluidi consultare i nostri tecnici)
Materiali	(A) Corpo = Tecnopolimero (PA11), Ottone a basso contenuto di piombo (CW510L) (B) Pulsante = Tecnopolimero (PA66) (C) Gripping ring = Acciaio inox (AISI 301) (D) Guarnizioni = EPDM (E) Filetto = Ottone a basso contenuto di piombo (CW510L)

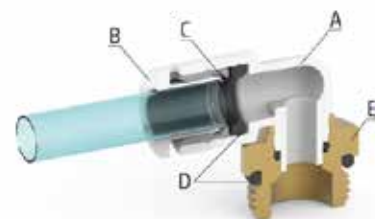

Raccordi Mod. B6512

Connettore dritto maschio
Ottone a basso contenuto di piombo (CW510L)
Filetto GAS cilindrico ISO-228 BSPP



NSF169



NSF61

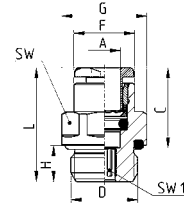

Mod.	A	D	C	F	G	H	L	SW	SW1	Peso (g)
B6512 4-1/8	4	G1/8	14,6	8,8	13,5	6	20	12	2,5	8
B6512 4-1/4	4	G1/4	14,6	8,8	16,4	7	21,5	15	2,5	12
B6512 6-1/8	6	G1/8	15,5	11,7	13,5	6	21	12	4	8
B6512 6-1/4	6	G1/4	15,5	11,7	16,4	7	22	15	4	11
B6512 8-1/8	8	G1/8	17,3	13,7	15,2	6	26	14	5	12
B6512 8-1/4	8	G1/4	17,3	13,7	16,4	7	24,5	15	6	14
B6512 8-3/8	8	G3/8	17,3	13,7	20,5	7	24	19	7	24

Raccordi Mod. B6812

Adattatore dritto maschio
Ottone a basso contenuto di piombo (CW510L)
Filetto GAS cilindrico ISO-228 BSPP



NSF169



NSF61

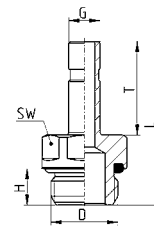

Mod.	D	G	H	L	T	SW	Peso (g)
B6812 4-1/8	G1/8	4	6	29	16,5	12	9
B6812 4-1/4	G1/4	4	7	30	16,5	15	14
B6812 6-1/8	G1/8	6	6	30,5	18	12	10
B6812 6-1/4	G1/4	6	7	31,5	18	15	14,5
B6812 8-1/8	G1/8	8	6	33	20,5	12	12
B6812 8-1/4	G1/4	8	7	34	20,5	15	16,5
B6812 8-3/8	G3/8	8	7	36	20,5	19	26

Raccordi Mod. B7522

Gomito maschio girevole
Filetto GAS cilindrico ISO-228 BSPP

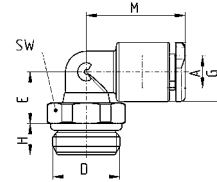

Mod.	A	D	E	G	H	M	SW	Peso (g)
B7522 4-1/8	4	G1/8	9	9,2	5	17	12	7
B7522 4-1/4	4	G1/4	9	9,2	6	17	14	10
B7522 6-1/8	6	G1/8	10	11,4	5	19	12	8
B7522 6-1/4	6	G1/4	10	11,4	6	19	14	11
B7522 8-1/8	8	G1/8	13,5	13,7	5	21,5	12	11
B7522 8-1/4	8	G1/4	12	13,7	6	21,5	14	14
B7522 8-3/8	8	G3/8	12	13,7	7	21,5	19	19

Raccordi Mod. B7800

Dritto innestabile ridotto

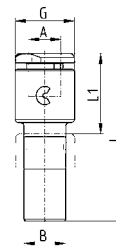

Mod.	A	B	G	L	L1	Peso (g)
B7800 4-6	4	6	9,3	29,5	14	2
B7800 4-8	4	8	9,3	30,5	14	3
B7800 6-8	6	8	11,4	32,5	15,5	4

Raccordi Mod. B7555

Gomito innestabile pari

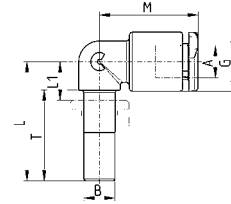

Mod.	A	B	G	L	L1	M	T	Peso (g)
B7555 4-4	4	4	9,2	21	7	17	16,5	2
B7555 6-6	6	6	11,4	23	8	19	17,5	4
B7555 8-8	8	8	13,7	25	9	21,5	18,5	5

Raccordi Mod. B7580

Diritto intermedio pari

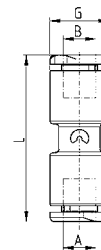

Mod.	A	B	G	L	Peso (g)
B7580 4	4	4	9,2	29,2	4
B7580 6	6	6	11,4	32	6
B7580 8	8	8	13,7	35,4	8

Raccordi Mod. B7550

Gomito intermedio pari

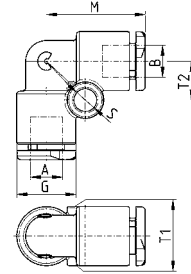

Mod.	A	B	G	M	S	T1	T2	Peso (g)
B7550 4	4	4	9,2	17	4	9,2	6,5	4
B7550 6	6	6	11,4	19	4	11,4	7,5	6
B7550 8	8	8	13,7	21,5	4	13,7	8,5	9

Raccordi Mod. B7540

T intermedio pari

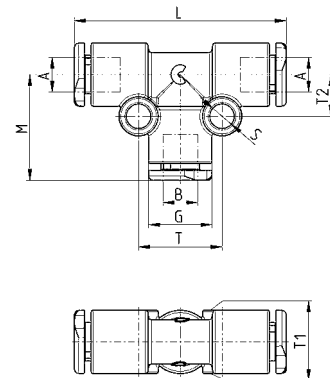

Mod.	A	B	G	L	M	S	T	T1	T2	Peso (g)
B7540 4	4	4	9,2	34	17	4	12	9,2	6,5	6
B7540 6	6	6	11,4	38	19	4	15	11,4	7,5	9
B7540 8	8	8	13,7	43	21,5	4	17	13,7	8,5	14

Raccordi Mod. B7560

Y intermedio pari

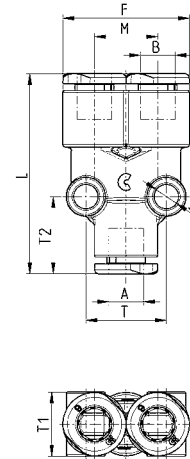

Mod.	A	B	F	L	M	S	T	T1	T2	Peso (g)
B7560 4	4	4	18,2	33,2	9	4	10,8	9,5	13	6
B7560 6	6	6	23	36	11,4	4	14,5	11,5	14	9
B7560 8	8	8	27,2	41,5	13,5	4	17	14	15	15

Accessorio Mod. B6900

Tappo maschio in plastica

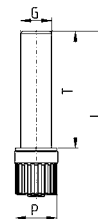

Mod.	G	L	P	T	Peso (g)
B6900 4	4	29	8	20	1
B6900 6	6	31,5	8	22,5	1
B6900 8	8	34,5	12	24,5	2

Scanalatura per tubo metallico ottenuta da taglia riga tubi 8TRT (o da lavorazione)

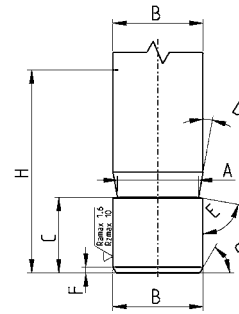

Code	A	B	C	D	E	F	G	H
—	3,4	4	5,3	10°	80°	0,5	30°	16,5
—	5,2	6	6,25	10°	80°	0,5	30°	18
—	7,2	8	6,4	10°	80°	0,5	30°	20

Scanalatura per tubo metallico ottenuta da lavorazione

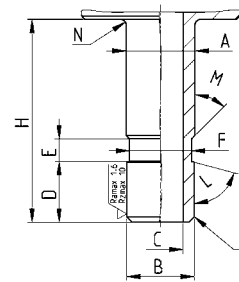

Code	A	B	C	D	E	F	G	H	L	M	N
—	4,1	4	2	5,3	2	3,5	0,5x45°	16,5	75°	45°	0,5
—	6,1	6	4	5,4	2	5,5	0,5x45°	18	75°	45°	0,5
—	8,1	8	6	6	2	7,5	0,5x45°	20,5	75°	45°	0,5

Taglia riga tubi

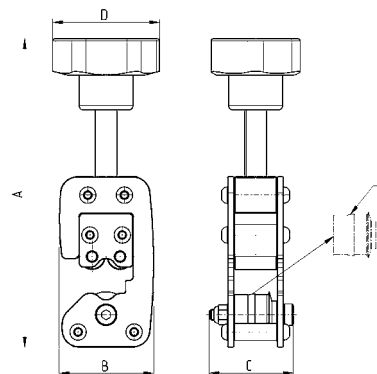

Mod.	Ø Tubo	A (max)	B	C	D	Peso (g)	E (rotella di ricambio)
8TRT 4	4	138	43.5	39	50	450	RTRT 4
8TRT 6	6	140	43.5	39	50	450	RTRT 6
8TRT 8	8	142	43.5	39	50	450	RTRT 8