

Raccordi in tecnopolimero Serie 7000 per raffreddamento ad acqua

Diametri esterni tubo: 6, 8, 10, 12, 16 mm
Filetti dei raccordi: BSP (G1/8, G1/4, G3/8, G1/2, G3/4)

RACCORDI PER ACQUA SERIE 7000 IN TECNOPOLIMERO



I raccordi Push-in della Serie 7000 Fluidics consentono di gestire il passaggio dei fluidi nei sistemi di raffreddamento. I sistemi di raffreddamento a liquido sono considerati migliori di quelli ad aria, in termini di efficienza, efficacia, compattezza e rumorosità. Il tema della gestione termica abbraccia innumerevoli applicazioni e settori, da quelli industriali a quelli legati a server e computer. La gamma di raccordi Serie 7000 Fluidics è realizzata con uno speciale tecnopolimero ottenuto da materie prime rinnovabili. Questo materiale consente al componente di resistere all'assorbimento dell'acqua, alle variazioni di temperatura e alle principali sostanze chimiche contenute nei liquidi di raffreddamento. Inoltre, garantisce una stabilità dimensionale costante a contatto con i diversi fluidi, migliorando la durata di vita del raccordo.

La consolidata tecnologia della pinza di afferraggio rende la Serie 7000 Fluidics un'ottima alternativa ai raccordi tradizionali, garantendo una tenuta omogenea su tutta la superficie del tubo favorendo un'elevata affidabilità e resistenza alle ripetute connessioni e disconnessioni del tubo stesso. Connessione affidabile, dimensioni compatte, facilità di installazione in spazi ridotti sono solo alcune delle caratteristiche che rendono questi nuovi raccordi una soluzione innovativa in grado di soddisfare le principali esigenze applicative dei sistemi di raffreddamento.

- » VANTAGGI:
- » Facilità di connessione e disconnessione
- » Resistente alla pressione dell'acqua e all'erosione
- » Resistente alla corrosione
- » Stabilità dimensionale a contatto con l'acqua
- » Lunga durata

CARATTERISTICHE GENERALI

Diametri	Ø6mm	Ø8mm	Ø10mm	Ø12mm	Ø16mm
Pressione d'esercizio -20°/+40°	16bar	16bar	14bar	14bar	12bar
Pressione d'esercizio -20°/+70°	16bar	14bar	12bar	10bar	8bar
Pressione d'esercizio -20°/+100°	14bar	12bar	10bar	8bar	6bar
Filettature	GAS cilindrico ISO-228 (BSPP)				
Tubo di collegamento	Poliuretano (PU), Polietilene (PE), Poliammide (PA), Fluoropolimero (PTFE)				
Fluido	acque industriali, acque additivate (per altri di fluidi consultare i nostri tecnici)				
Materiali	corpo in tecnopolimero PA11; guarnizione in EPDM; Filettature in nichelatura chimica; Pinza (non a contatto con fluidi) nichelata				

Raccordo con tubo di collegamento

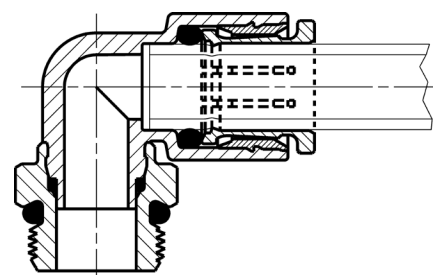

Raccordi Mod. F6512K



Diritto Maschio Cilindrico

* = Clip di bloccaggio integrata per fissare la pinza nella sua posizione

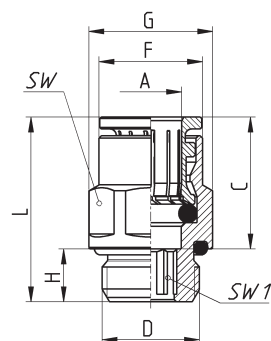

DIMENSIONI										
Mod.	A	D	C	F	G	H	L	SW	SW1	Peso (g)
F6512 6-1/8K	6	G1/8	16.0	11.7	13.5	6	21	12	4	10
F6512 6-1/4K	6	G1/4	16.0	11.7	16.4	7	22	15	4	13
F6512 8-1/8K	8	G1/8	17.5	13.7	15.2	6	26	14	5	15
F6512 8-1/4K	8	G1/4	17.5	13.7	16.4	7	24.5	15	6	17
F6512 8-3/8K	8	G3/8	17.5	13.7	20.5	7	23	19	6	27
F6512 10-1/4K	10	G1/4	20.2	15.4	18.5	7	30	17	7	26
F6512 10-3/8K	10	G3/8	20.2	15.4	20.5	7	24.5	19	8	27
F6512 10-1/2K	10	G1/2	20.2	15.4	24.8	8	25	22	8	39
F6512 12-3/8K	12	G3/8	19.2	18.3	20.5	7	24	19	9	24
F6512 12-1/2K	12	G1/2	19.2	18.3	24.8	8	24.5	22	9	37
F6512 16-1/2K*	16	G1/2	23.0	23.5	26.5	8	33.5	24	-	49
F6512 16-3/4K*	16	G3/4	23.0	23.5	30	9	29.5	24	-	58

Raccordi Mod. F6463K



Diritto Femmina Cilindrico

* = Clip di bloccaggio integrata per fissare la pinza nella sua posizione

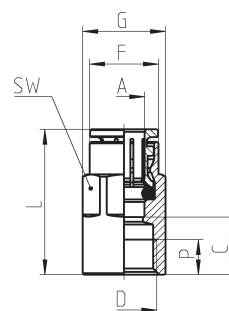

DIMENSIONI										
Mod.	A	D	C	F	G	L	P (min)	SW	Peso (g)	
F6463 6-1/8K	6	G1/8	10	11.7	13	26	6	12	14	
F6463 6-1/4K	6	G1/4	11.5	11.9	16.5	27.5	7	15	23	
F6463 8-1/8K	8	G1/8	9.5	13.7	15.2	27	6	14	16	
F6463 8-1/4K	8	G1/4	11.5	13.7	16.5	29	7	15	23	
F6463 8-3/8K	8	G3/8	13	13.7	20	30.5	8	15	29	
F6463 10-1/4K	10	G1/4	11.3	15.4	18.5	31.5	7	17	29	
F6463 10-3/8K	10	G3/8	12.8	15.4	20	33	8	17	34	
F6463 10-1/2K	10	G1/2	16.8	15.4	24	37	9.5	17	44.5	
F6463 12-3/8K	12	G3/8	12.8	18.3	20.5	32	8	19	40	
F6463 12-1/2K	12	G1/2	16.8	18.3	24	36	9.5	19	50.5	
F6463 16-1/2K*	16	G1/2	16.5	23.5	26.5	40	9.5	24	63	
F6463 16-3/4K*	16	G3/4	18.5	23.5	30	42	11	24	77	

Raccordi Mod. F6700K

Cartuccia



S* = sia per sede metallica
che per sede sintetica

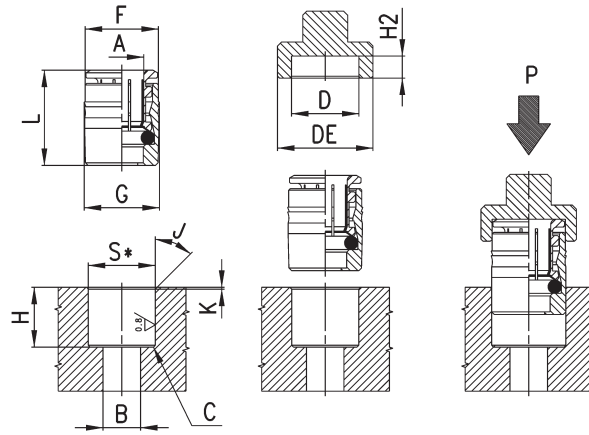

Mod.	A	B	C	D	DE	F	G	H	H2 (+0,1/0)	J	K	L	P min (Kg)	P max (Kg)	S (+0,01/-0,04)	Peso (g)
F6700 6K	6	4	0.5x45°	12	17	11.8	12.2	12	3.8	15°	0.5	16.5	160	570	11.95	8
F6700 8K	8	6	0.5x45°	14	19	13.8	14.2	14	3.3	15°	0.5	18	140	400	13.95	11
F6700 10K	10	8	0.5x45°	16	21	15.8	16.2	16.5	3.5	15°	0.5	20.5	150	650	15.95	15

Raccordi Mod. F7522K

Gomito Girevole Cilindrico Maschio



* = Clip di bloccaggio integrata per fissare la pinza
nella sua posizione

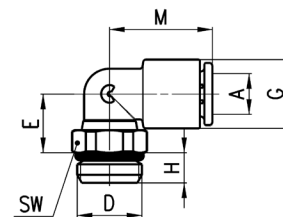

DIMENSIONI								
Mod.	A	D	E	G	H	M	SW	Peso (g)
F7522 6-M5K	6	M5	9.3	11.4	3.5	18.5	9	7
F7522 6-1/8K	6	G1/8	10	11.6	5	18.5	12	8
F7522 6-1/4K	6	G1/4	10	11.6	6	18.5	14	11
F7522 8-1/8K	8	G1/8	13.5	13.9	5	20.5	12	11
F7522 8-1/4K	8	G1/4	12	13.9	6	20.5	14	13
F7522 8-3/8K	8	G3/8	12.5	13.9	7	20.5	19	21
F7522 10-1/4K	10	G1/4	14.5	16.1	6	24	14	15
F7522 10-3/8K	10	G3/8	13.5	16.1	7	24	19	21
F7522 10-1/2K	10	G1/2	13.5	16.1	8	24	24	30
F7522 12-3/8K	12	G3/8	15	20.2	7	28	19	25
F7522 12-1/2K	12	G1/2	15.5	20.2	8	28	24	34
F7522 16-1/2K*	16	G1/2	30	27	8	33.5	24	61
F7522 16-3/4K*	16	G3/4	24	27	9	33.5	30	70

Raccordi Mod. F7526K



Gomito Girevole Prolungato
Cilindrico Maschio

* = Clip di bloccaggio integrata per fissare la pinza nella sua posizione

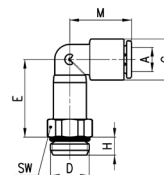

DIMENSIONI								
Mod.	A	D	E	G	H	M	SW	Peso (g)
F7526 6-1/8K	6	G1/8	23	11,6	5	18,5	12	13
F7526 6-1/4K	6	G1/4	23	11,6	5	18,5	14	16
F7526 8-1/8K	8	G1/8	29	13,9	5	20,5	12	18
F7526 8-1/4K	8	G1/4	27	13,9	6	20,5	14	20
F7526 8-3/8K	8	G3/8	27,7	13,9	7	20,5	19	30
F7526 10-1/4K	10	G1/4	32,2	15,8	6	24	14	28,5
F7526 10-3/8K	10	G3/8	32,2	15,8	7	24	19	35
F7526 10-1/2K	10	G1/2	32,2	15,8	8	24	24	45
F7526 12-3/8K	12	G3/8	36,2	20	7	28	19	41,5
F7526 12-1/2K	12	G1/2	36,2	20	8	28	24	49,5
F7526 16-1/2K*	16	G1/2	58,9	27	8	34	24	106,5
F7526 16-3/4K*	16	G3/4	58,9	27	9	34	30	116

Raccordi Mod. F7550



Gomito Intermedio

* = Clip di bloccaggio integrata per fissare la pinza nella sua posizione

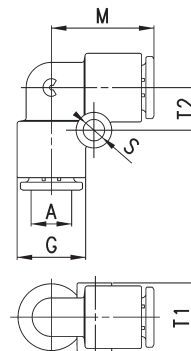

DIMENSIONI							
Mod.	A	G	M	S	T1	T2	Peso (g)
F7550 6	6	11,6	18,5	4	11,4	7,5	6
F7550 8	8	13,9	20,5	4	13,7	8,5	9
F7550 10	10	16,1	24	4	15,8	8	12
F7550 12	12	20,2	28	4	9	9,6	20
F7550 16*	16	27	33,5	-	-	-	42

F7550 16 = modello senza fori di fissaggio

Raccordi Mod. F7580



Diritto Intermedio

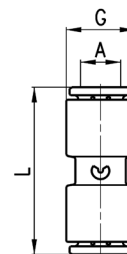

DIMENSIONI				
Mod.	A	G	L	Peso (g)
F7580 6	6	11,6	31	6
F7580 8	8	13,9	33,5	9
F7580 10	10	16,1	38,5	11
F7580 12	12	20,2	39,5	18

Raccordi Mod. F7540

T Intermedio



* = Clip di bloccaggio integrata per fissare la pinza nella sua posizione

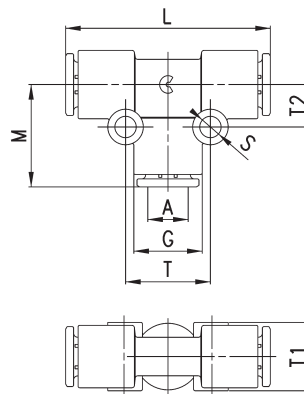

DIMENSIONI									
Mod.	A	G	L	M	S	T	T1	T2	Peso (g)
F7540 6	6	11,6	37	18,5	4	15	11,4	7,5	9
F7540 8	8	13,9	41	20,5	4	17	13,7	8,5	14
F7540 10	10	16,1	48	24	4	16	15,8	8	18
F7540 12	12	20,2	56	28	4	19,2	9	9,6	30
F7540 16*	16	27	67	33,5	-	-	-	-	61

F7540 16 = modello senza fori di fissaggio

Raccordi Mod. F7560

Y Intermedio Ridotto

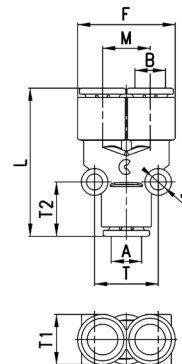

DIMENSIONI										
Mod.	A	B	F	L	M	S	T	T1	T2	Peso (g)
F7560 6	6	6	23	35	11,4	4	14,5	11,5	13,5	9
F7560 8	8	8	27,2	39,5	13,5	4	17	14	14,5	15
F7560 10	10	10	31,7	46	15,8	4	16,5	16	16,5	19

Raccordi Mod. F7545

Multi T Ridotto

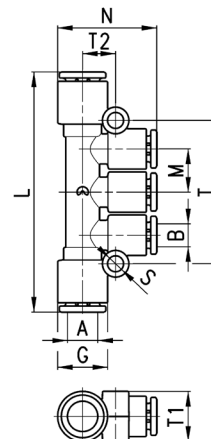

DIMENSIONI											
Mod.	A	B	G	L	M	N	S	T	T1	T2	Peso (g)
F7545 8-6	8	6	13,9	64	11,5	26,5	4	38,2	13,5	9	18
F7545 10-8	10	8	16,1	78,5	14,1	30	4	45,8	16	10,5	27

Raccordi Mod. F7555

Gomito con Codolo Innestabile

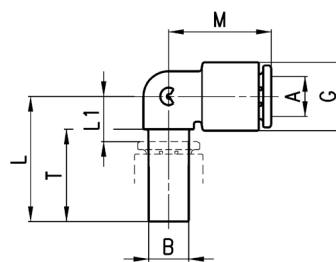

DIMENSIONI								
Mod.	A	B	G	L	L1	M	T	Peso (g)
F7555 6-6	6	6	11,6	23	8	18,5	17,5	4
F7555 8-8	8	8	13,9	25	9	20,5	18,5	5
F7555 10-10	10	10	16,1	28,5	10	24	21	8
F7555 12-12	12	12	20,2	32	13	28	23	12

Raccordi Mod. F7800

Riduzione

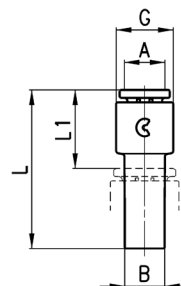

DIMENSIONI						
Mod.	A	B	G	L1	L	Peso (g)
F7800 4-6	4	6	9,4	14,5	29,5	2
F7800 4-8	4	8	9,4	14,5	30,5	3
F7800 6-8	6	8	11,6	15,5	31,5	4
F7800 6-10	6	10	11,6	15,5	34	4
F7800 6-12	6	12	11,6	16,5	35,5	4
F7800 8-10	8	10	13,9	16,5	35	5
F7800 8-12	8	12	13,9	17,5	37	6
F7800 10-12	10	12	16,1	18,5	37,5	7

Raccordi Mod. F6750K

Tappo femmina

* = Clip di bloccaggio integrata per fissare la pinza nella sua posizione

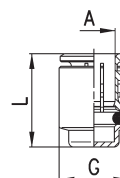

DIMENSIONI				
Mod.	A	G	L	Peso (g)
F6750 6K	6	11.8	17	7
F6750 8K	8	13.8	18.5	9
F6750 10K	10	15.8	21	12
F6750 12K	12	17.8	20	15
F6750 16K*	16	23.5	24.5	26

Accessorio Mod. 6900



Tappo Maschio in plastica

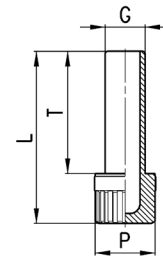

DIMENSIONI					
Mod.	G	L	P	T	Peso (g)
6900 6	6	31.5	8	22.5	1
6900 8	8	34.5	12	24.5	2
6900 10	10	37	12	27	2
6900 12	12	40.5	16	28.5	3

Raccordi Mod. 2611

Tappo Maschio Cilindrico

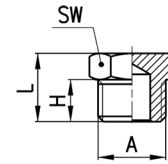

DIMENSIONI					
Mod.	A	H	L	SW	Peso (g)
2611 1/8	G1/8	6	10,5	13	7
2611 1/4	G1/4	8	13	17	13
2611 3/8	G3/8	9	14	19	18
2611 1/2	G1/2	10	15,5	24	31
2611 1	G1	13	19	38	76

Accessori Mod. 3033

Bloccetto 4 Vie con fori di fissaggio
Materiale: Alluminio anodizzato

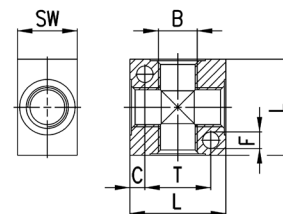
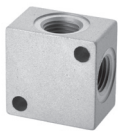

DIMENSIONI							
Mod.	B	C	F	L	T	SW	Peso (g)
3033 1/8	G1/8	4	4,5	25	17	16	18
3033 1/4	G1/4	5	5,5	32	22	20	35
3033 3/8	G3/8	7	5,5	40	26	25	73
3033 1/2	G1/2	8	5,5	50	34	30	137

Accessori Mod. 3043

Collettore con Uscite Contrapposte
Materiale: Alluminio anodizzato

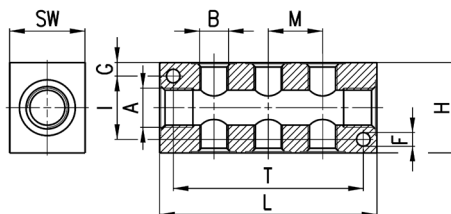

DIMENSIONI												
Mod.	A	USCITE LATERALI DOPPIE	B	F	G	H	I	L	M	T	SW	Peso (g)
3043 1/4-3D-1/8	G1/4	3	G1/8	4.5	4.5	30	21	72	18	63	20	85
3043 1/4-4D-1/8	G1/4	4	G1/8	4.5	4.5	30	21	90	18	81	20	107
3043 1/4-5D-1/8	G1/4	5	G1/8	4.5	4.5	30	21	108	18	99	20	128
3043 1/4-6D-1/8	G1/4	6	G1/8	4.5	4.5	30	21	126	18	117	20	151
3043 3/8-3D-1/4	G3/8	3	G1/4	5.5	6	40	28	92	24	75	25	177
3043 3/8-4D-1/4	G3/8	4	G1/4	5.5	6	40	28	116	24	99	25	224
3043 3/8-5D-1/4	G3/8	5	G1/4	5.5	6	40	28	140	24	123	25	270
3043 3/8-6D-1/4	G3/8	6	G1/4	5.5	6	40	28	164	24	147	25	315
3043 1/2-3D-3/8	G1/2	3	G3/8	5.5	6.5	50	37	104	26	85	30	287
3043 1/2-4D-3/8	G1/2	4	G3/8	5.5	6.5	50	37	130	26	111	30	356
3043 1/2-5D-3/8	G1/2	5	G3/8	5.5	6.5	50	37	156	26	137	30	427
3043 1/2-6D-3/8	G1/2	6	G3/8	5.5	6.5	50	37	182	26	163	30	495

Accessori Mod. 3053

Collettore con Uscite Laterali
Materiale: Alluminio anodizzato

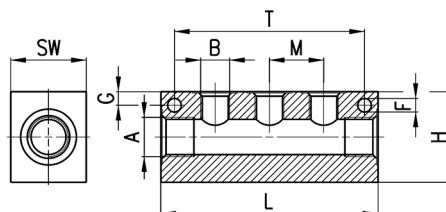

DIMENSIONI												
Mod.	A	USCITE LATERALI SINGOLE	B	F	G	H	L	M	T	SW	Peso (g)	
3053 1/4-3L-1/8	G1/4	3	G1/8	4,5	4,5	30	72	18	63	20	92	
3053 1/4-4L-1/8	G1/4	4	G1/8	4,5	4,5	30	90	18	81	20	116	
3053 1/4-5L-1/8	G1/4	5	G1/8	4,5	4,5	30	108	18	99	20	140	
3053 1/4-6L-1/8	G1/4	6	G1/8	4,5	4,5	30	126	18	117	20	164	
3053 3/8-3L-1/4	G3/8	3	G1/4	5,5	6	40	92	24	75	25	191	
3053 3/8-4L-1/4	G3/8	4	G1/4	5,5	6	40	116	24	99	25	243	
3053 3/8-5L-1/4	G3/8	5	G1/4	5,5	6	40	140	24	123	25	294	
3053 3/8-6L-1/4	G3/8	6	G1/4	5,5	6	40	164	24	147	25	345	
3053 1/2-3L-3/8	G1/2	3	G3/8	5,5	6,5	50	104	26	85	30	313	
3053 1/2-4L-3/8	G1/2	4	G3/8	5,5	6,5	50	130	26	111	30	395	
3053 1/2-5L-3/8	G1/2	5	G3/8	5,5	6,5	50	156	26	137	30	474	
3053 1/2-6L-3/8	G1/2	6	G3/8	5,5	6,5	50	182	26	163	30	551	